

МЕЛИССА СБ-2889/MELISSA SB-2889

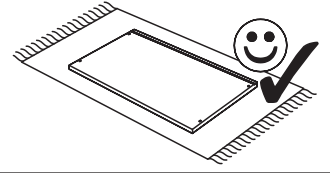

№	L	B	S	N	P
1	2000	330	16	1	2/3
2	2000	330	16	1	2/3
3	2000	330	16	1	2/3
4	562	330	16	1	1/3
5	562	330	16	1	1/3
6	268	330	16	1	1/3
7	1024	290	16	1	2/3
8	770	290	16	1	2/3
9	1992	290	19	2	3/3
10	350	880	16	1	1/3
11	880	350	16	1	1/3
12	268	310	16	4	1/3
13	290	190	16	1	2/3
14.1	214	94	16	1	1/3
14.2	300	115	16	1	1/3
14.3	300	115	16	1	1/3
14.4	224	305	3	1	1/3
15	2028	291	3	3	2/3

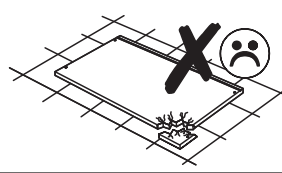

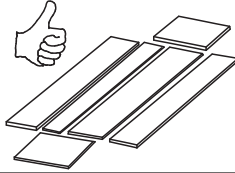
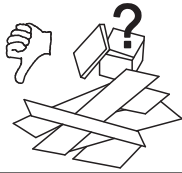
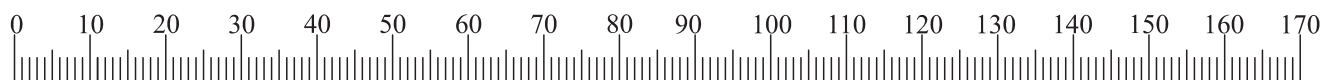
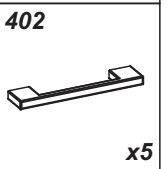
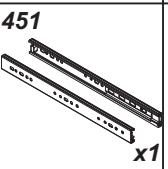
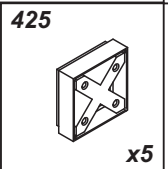
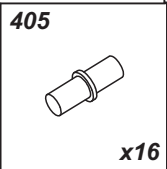
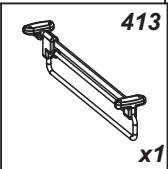
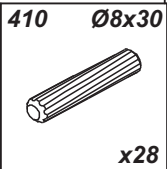
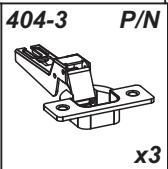
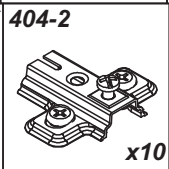
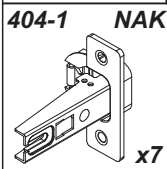
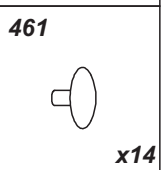
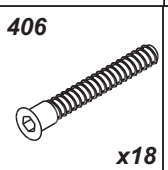
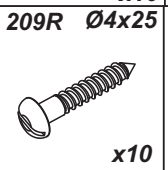
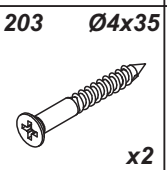
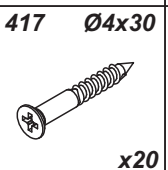
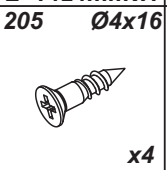
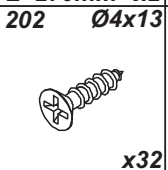
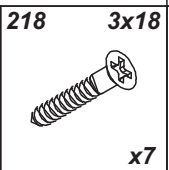
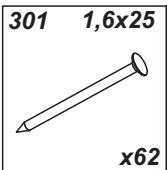
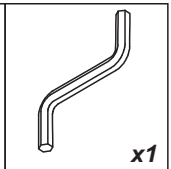
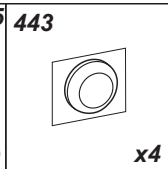
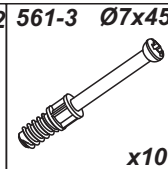
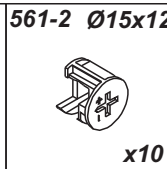
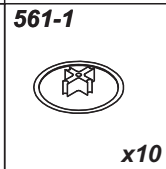
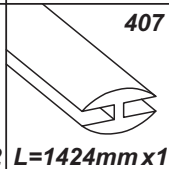
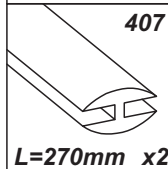
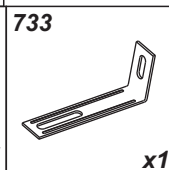
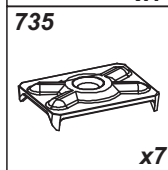
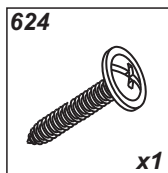
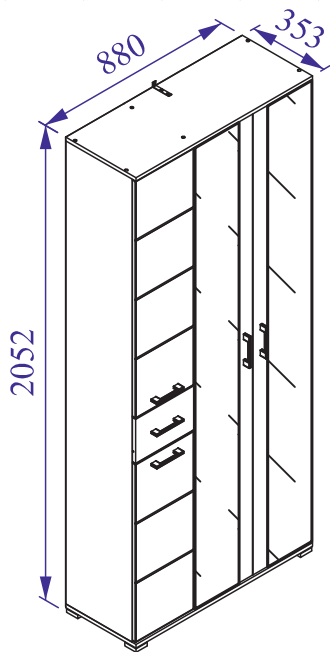
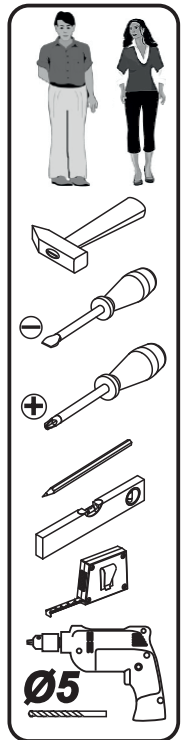
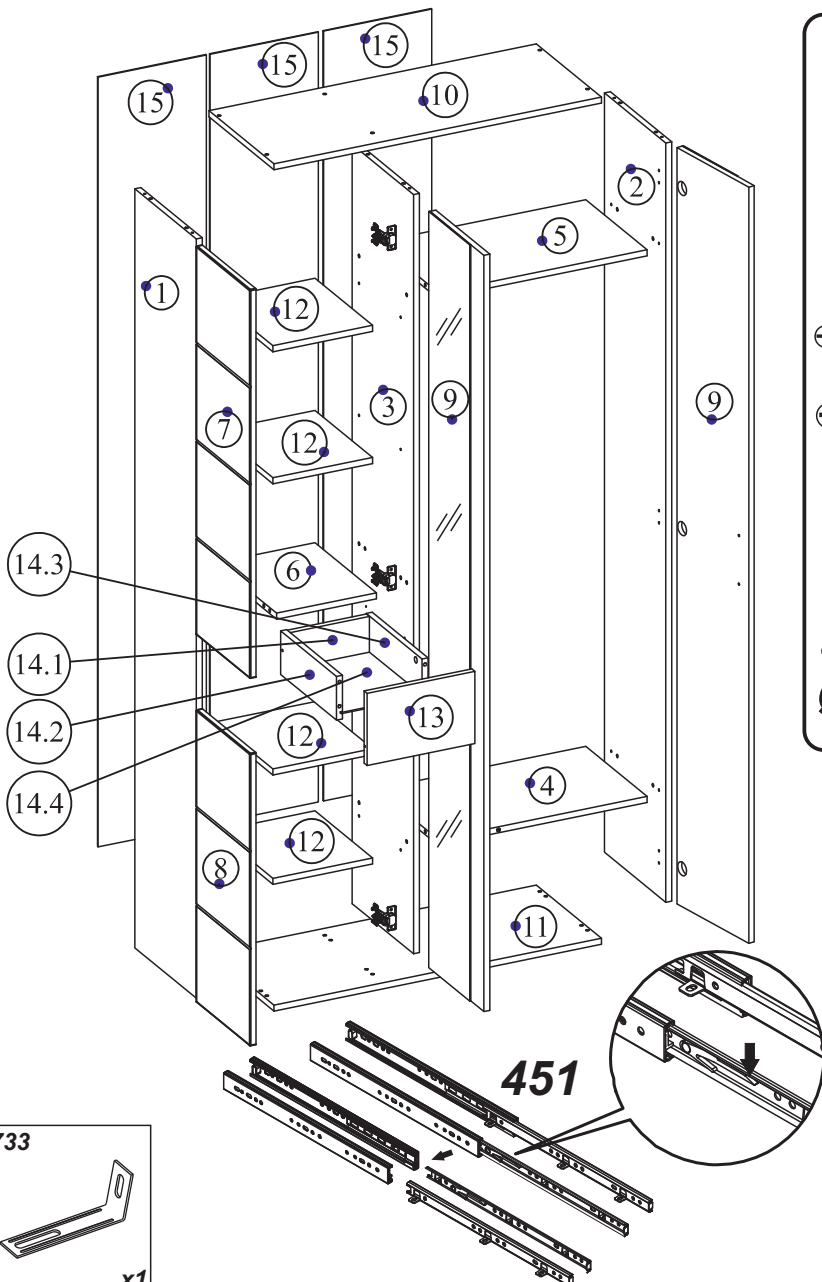
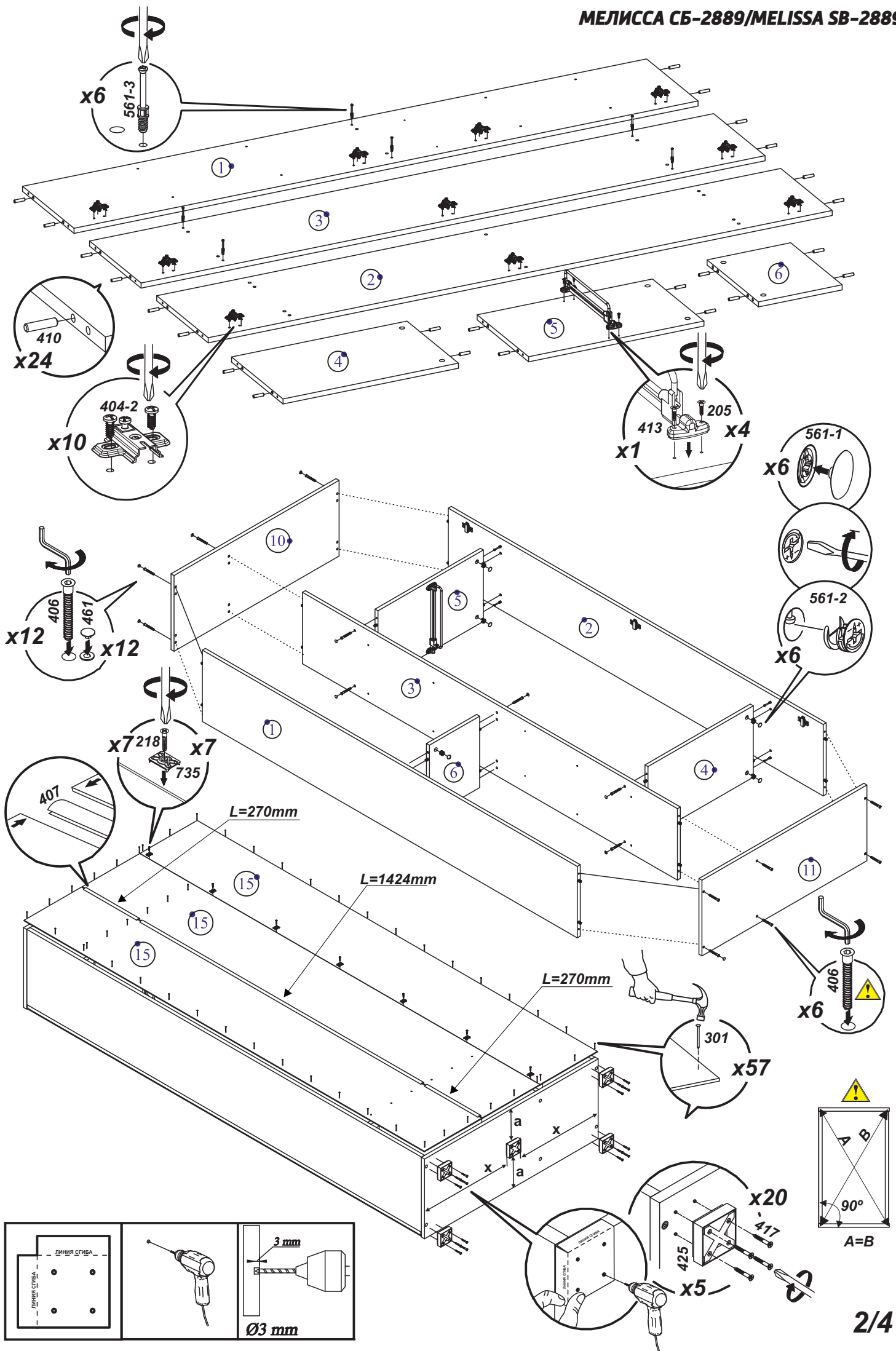

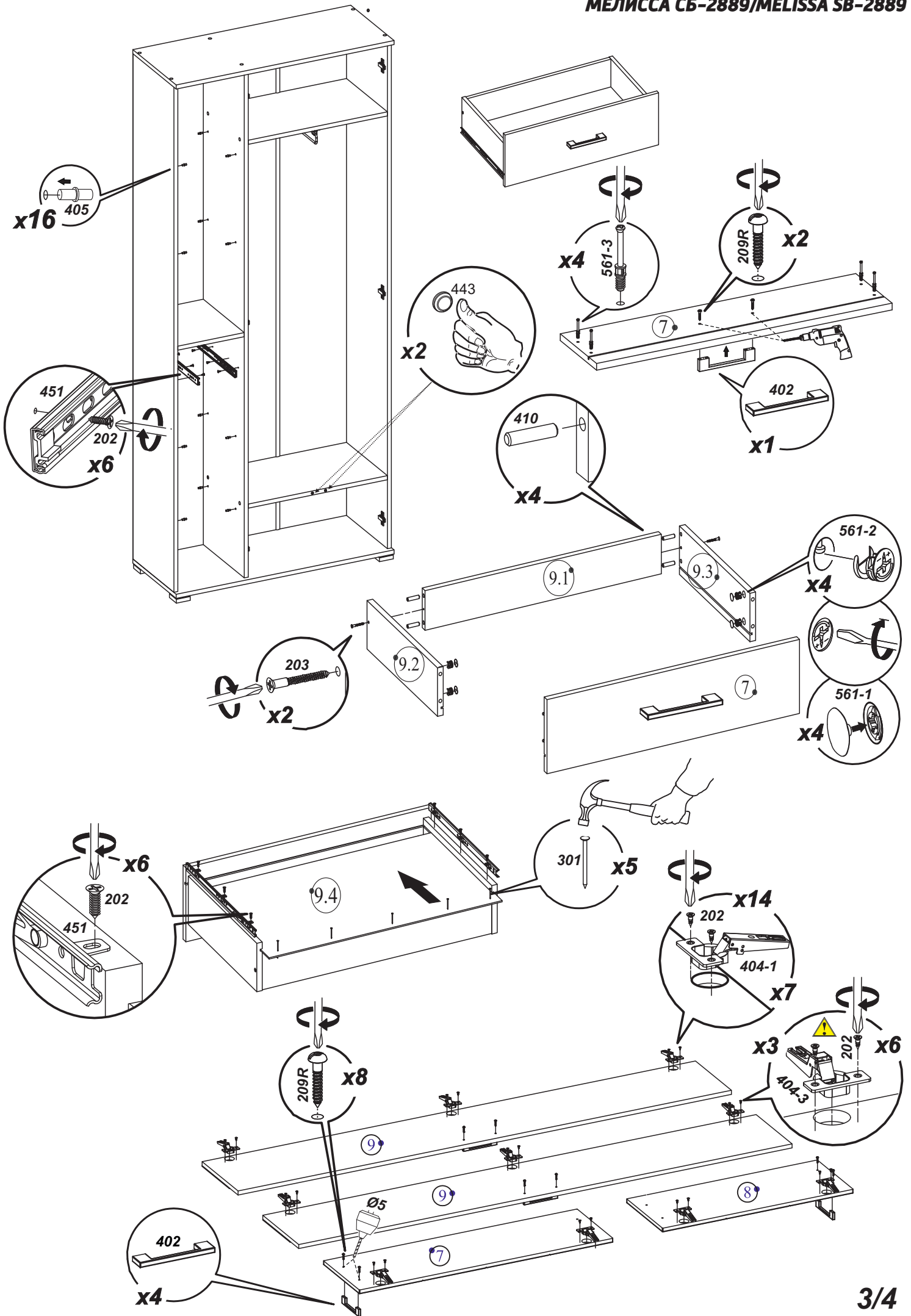

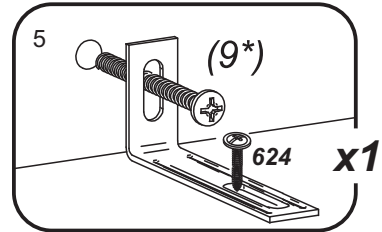
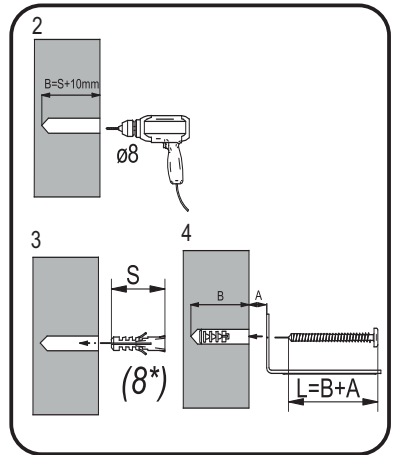
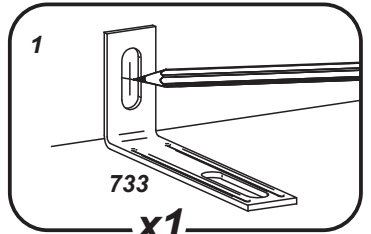
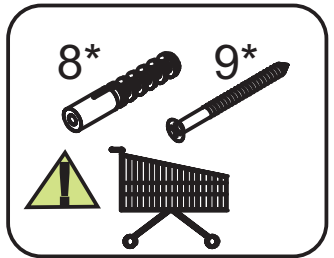
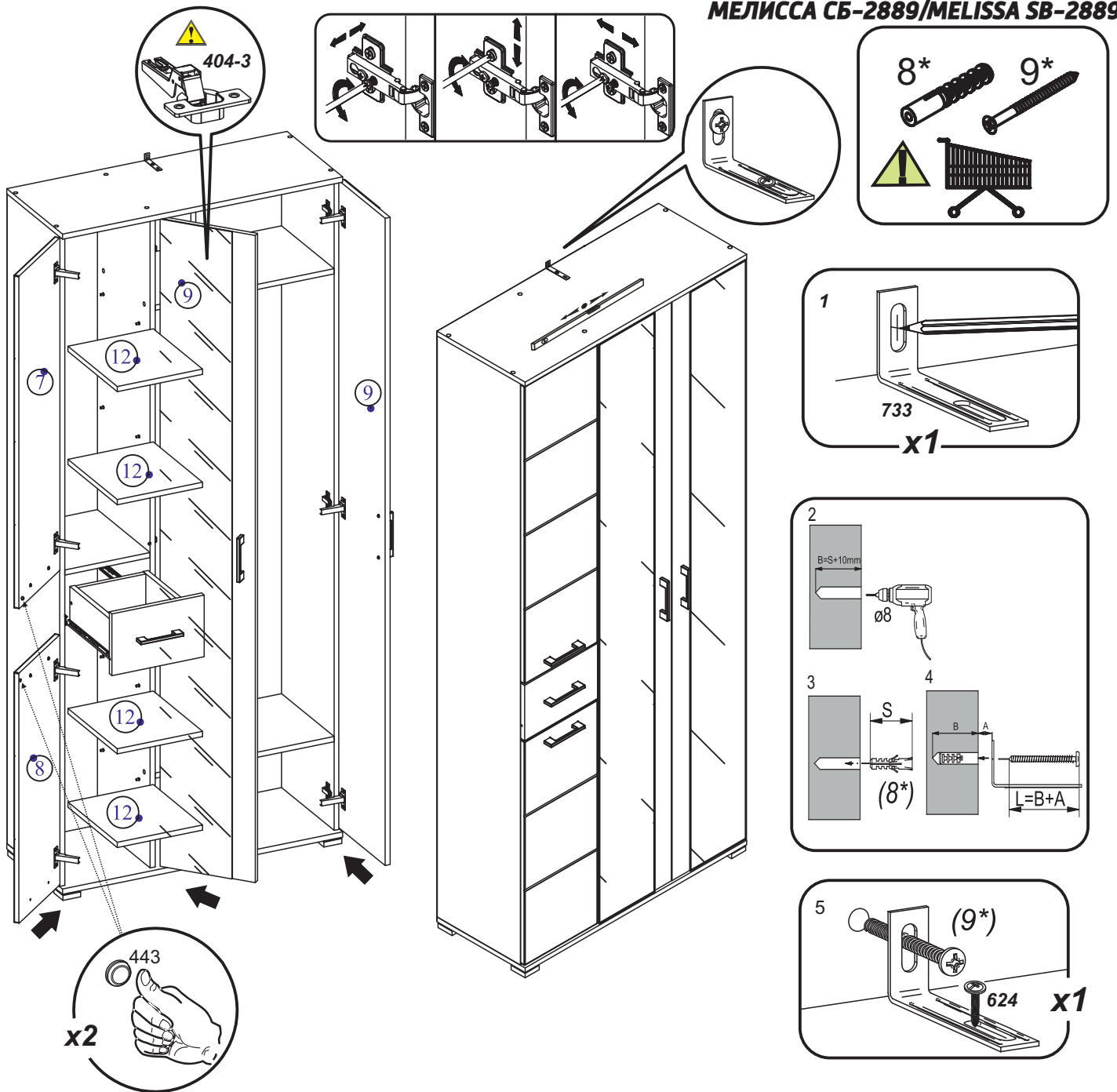

Шаблон для крепления опор поз. 425

